

EDITION / VERSİYON
07/2010

SLIDING SYSTEM
SÜRME SİSTEMİ

SYSTEM 45T
SİSTEM 45T

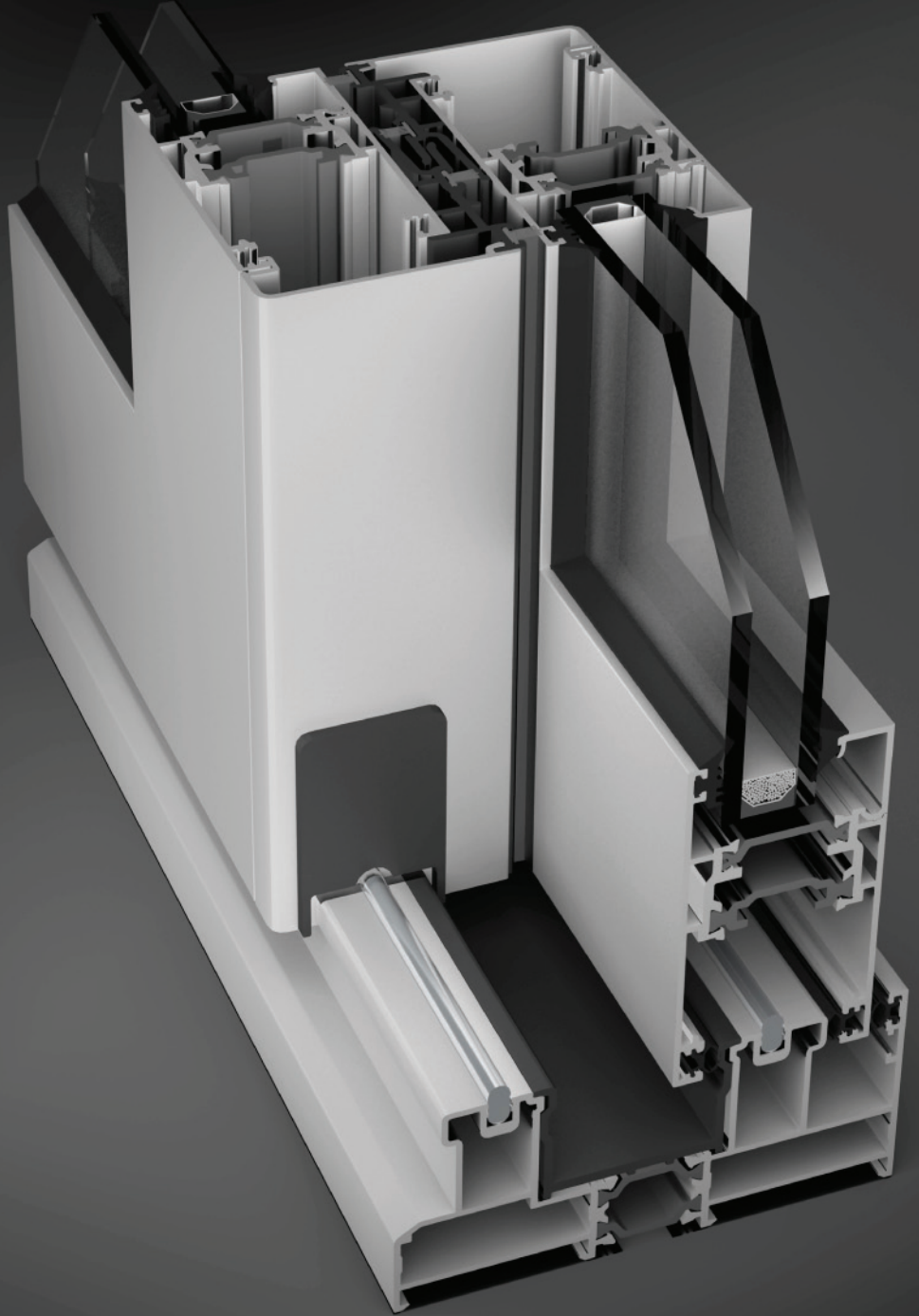

 **Lorenzoline**[®]
aluminium profile system



SLIDING SYSTEM SÜRME SİSTEMİ

SYSTEM 45T SİSTEM 45T

System Properties / Sistem Özellikleri

One Profile Two Different System

- 1- Sliding / Sürme
- 2- Lift & Slide / Kaldır Sür

Modern Design / Modern Dizayn

Wall Thickness / Et Kalınlığı : 1.5 mm

Vent Height / Kanat Geniřlięi : 45 mm

Isolation Bar / Isı Bariyeri : 32 mm

EPDM Gaskets / EPDM Fıtil

For Sliding - Brush / Sürme İin Fıra

For Lift & Slide - TPV Gasket / Kaldır Sür İin TPV Fıtil

Glazing From 20 mm to 34 mm

Cam Kullanımı 20 mm'den 34 mm

Thermal Permability / EPDM Fıtil : (Uf): 4.0 W/m²K

Code Logic / Kod Mantığı

45T

101

00

Factory Standard
Fabrika Standardı

Group / Grup

Title / Seri

Titles / Seriler

45T - System Name / Sistem Adı

09 - Extruded Corner Joints / Pres Köře Takozu

Groups / Gruplar

101, 102,... - Frames / Kasalar

201, 251,... - Vents / Kanatlar

301, 302,... - Mullions / Orta Kayıtlar

501, 502,... - Adaptors / Adaptörler

801, 802,... - Glazing Beats / Adaptörler

Alloy / Alařım

The alloys of the aluminium profiles are 6060 and 6063 (AlMgSi 0,5 - F22) based on EN 12020-2 / 755-9 standards

Alüminyum profil alařımları 6060 ve 6063 (AlMgSi 0,5 - F22)

EN 12020-2 / 755-9 standartlarına uygundur.

All drawings are not scaled.
Tüm çizimler öleksizdir.

TECHNICAL INFORMATIONS / TEKNİK AIKLAMALAR

Sliding Opportunities

Sürme Seçenekleri

SLIDING / Sürme

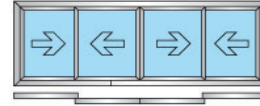
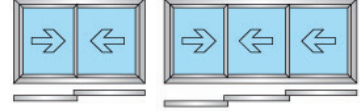

LIFT & SLIDE / Kaldır Sür

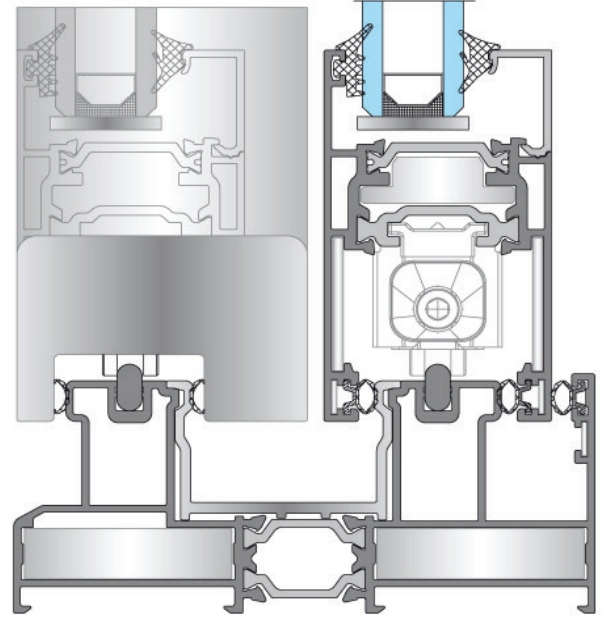
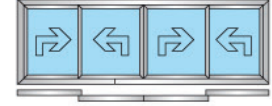
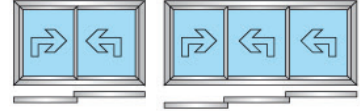

Sliding



EM45 - 02

Brush

Lift & Slide



EM45 - 03

TPV Gasket

Lorenzoline
aluminium profile system



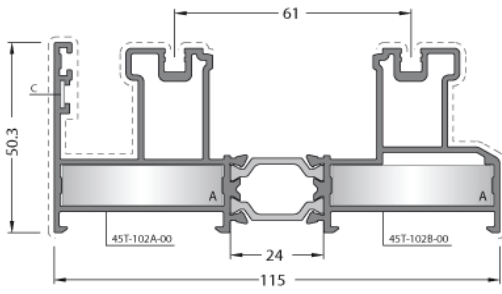

CODE / KOD

45T-102-00

THEORETICAL WEIGHT kg/m

TEORİK AĞIRLIK kg/m

2.317

EXTRUDED CORNER JOINT
KÖŞE TAKIYU

 A CC-101-41.1

 C LC-107

DIE-CAST CORNER JOINT
DÖKÜM BAĞLANTI

 A LC-1141

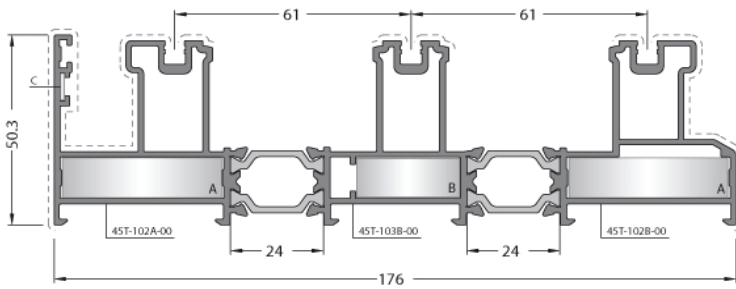

CODE / KOD

45T-103-00

THEORETICAL WEIGHT kg/m

TEORİK AĞIRLIK kg/m

3.507

EXTRUDED CORNER JOINT
KÖŞE TAKIYU

 A CC-101-41.1

 B CC-101-26.5

 C LC-107

DIE-CAST CORNER JOINT
DÖKÜM BAĞLANTI

 A LC-1141

 A LC-1127

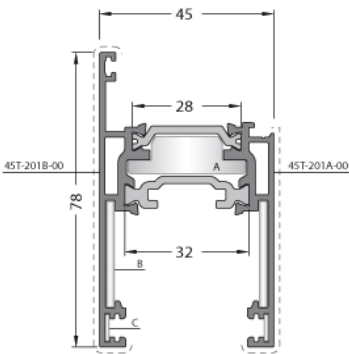

CODE / KOD

45T-201-00

THEORETICAL WEIGHT kg/m

TEORİK AĞIRLIK kg/m

1.427

CORNER JOINT
KÖŞE TAKIYU

 A 02923000

 B 02921000

 C LC-107

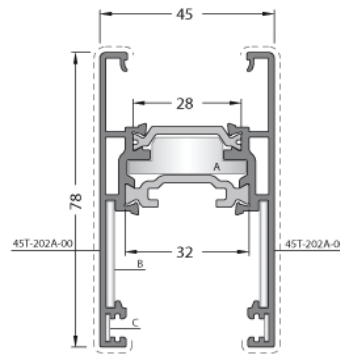

CODE / KOD

45T-202-00

THEORETICAL WEIGHT kg/m

TEORİK AĞIRLIK kg/m

1.546

CORNER JOINT
KÖŞE TAKIYU

 A 02923000

 B 02921000

 C LC-107

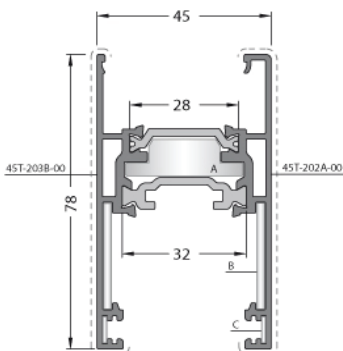

CODE / KOD

45T-203-00

THEORETICAL WEIGHT kg/m

TEORİK AĞIRLIK kg/m

1.517

CORNER JOINT
KÖŞE TAKIYU

 A 02923000

 B 02921000

 C LC-107

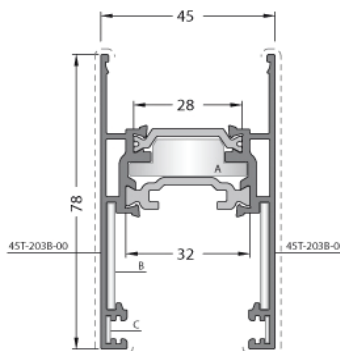

CODE / KOD

45T-204-00

THEORETICAL WEIGHT kg/m

TEORİK AĞIRLIK kg/m

1.488

CORNER JOINT
KÖŞE TAKIYU

 A 02923000

 B 02921000

 C LC-107

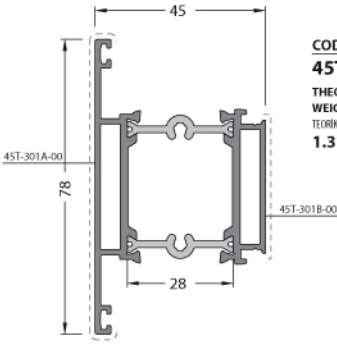

CODE / KOD
45T-301-00
THEORETICAL
WEIGHT kg/m
TEORİK AĞIRLIK kg/m
1.310

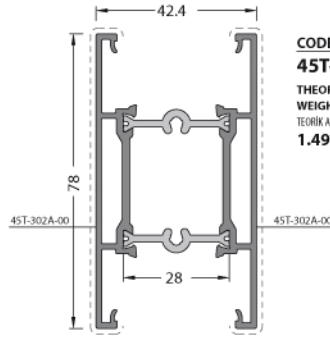

CODE / KOD
45T-302-00
THEORETICAL
WEIGHT kg/m
TEORİK AĞIRLIK kg/m
1.496

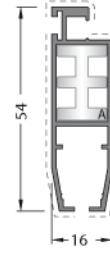

CODE / KOD
1621
THEORETICAL
WEIGHT kg/m
TEORİK AĞIRLIK kg/m
0.499
DIE-CAST
CORNER JOINT
KOŞE TARDUZI
 **A MS 13**

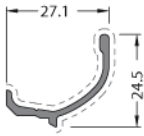

CODE / KOD
45T-501-00
THEORETICAL
WEIGHT kg/m
TEORİK AĞIRLIK kg/m
0.219

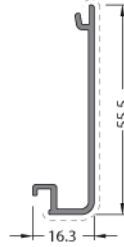

CODE / KOD
45T-502-00
THEORETICAL
WEIGHT kg/m
TEORİK AĞIRLIK kg/m
0.328



No visible surface
Görünen yüzeyi yoktur
CODE / KOD
45T-503-00
THEORETICAL
WEIGHT kg/m
TEORİK AĞIRLIK kg/m
0.427



CODE / KOD
45T-802-00
THEORETICAL
WEIGHT kg/m
TEORİK AĞIRLIK kg/m
0.145

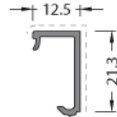

CODE / KOD
45T-803-00
THEORETICAL
WEIGHT kg/m
TEORİK AĞIRLIK kg/m
0.161



No visible surface
Görünen yüzeyi yoktur
CODE / KOD
13-134-050R
THEORETICAL
WEIGHT kg/m
TEORİK AĞIRLIK kg/m
0.118

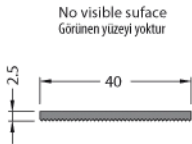

No visible surface
Görünen yüzeyi yoktur
CODE / KOD
45T-508-00
THEORETICAL
WEIGHT kg/m
TEORİK AĞIRLIK kg/m
0.244

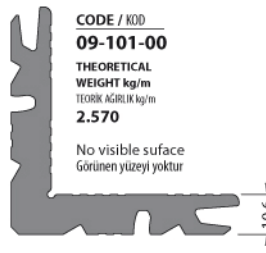

CODE / KOD
09-101-00
THEORETICAL
WEIGHT kg/m
TEORİK AĞIRLIK kg/m
2.570

No visible surface
Görünen yüzeyi yoktur

GASKETS / FİTİLLER

CODE KOD	DRAWING ÇİZİM	APLICATION UYGULAMA	DESCRIPTION AÇIKLAMA	WEIGHT kg/m AGIRLIK kg/m	IN ONE PACKAGE PAKET MİKTARI
EM1-02			Glazing Gasket Inside (EPDM) İç Cam Fıtlı	0.050	300 m
EM1-03			Glazing Gasket Inside (EPDM) İç Cam Fıtlı	0.060	250 m
EM1-04			Glazing Gasket Inside (EPDM) İç Cam Fıtlı	0.070	215 m
EM2-01			Glazing Gasket Outside (EPDM) Dış Cam Fıtlı	0.055	270 m
EM45-02			Brush Fırça	-	225 m
EM45-03			TPV Gasget TPV Fıtlı	0.019	300 m
EM45-05			F & S Frame Gasget F&S Fıtlı	0.030	500 m

GLAZING COMBINATION / CAM KOMBİNASYONLARI

GLAZING THICKNESS ÇİZİM	GLAZING GASKET INSIDE İÇ CAM FİTLİ	GLAZING GASKET OUTSIDE DİŞ CAM FİTLİ	GLAZING BEAD CAM ÇİTASI
20 mm	EM1-04	EM1-04	45-202-00
22 mm	EM1-03	EM1-03	45-202-00
24 mm	EM1-02	EM1-02	45-202-00
26 mm	EM1-03	EM1-04	45-203-00
28 mm	EM1-02	EM1-03	45-203-00
28 mm	EM1-04	EM1-04	45-204-00
30 mm	EM1-03	EM1-03	45-204-00
32 mm	EM1-02	EM1-02	45-204-00

ACCESSORY CODE AKSESUAR KODU	DRAWING ÇİZİM	DESCRIPTION AÇIKLAMA	APPLICATION DETAIL UYGULAMA DETAYI
EM15 - 200		ROD PROFILE	

GASKETS / FİTİLLER









CODE KOD	DRAWING ÇİZİM	PACKAGE CODE PAKET KODU	QUANTITY MİKTAR	CUTTING SIZE KESİM ÖLÇÜSÜ	APPLICATION PROFILES UYGULAMA PROFİLLERİ	APPLICATION DETAILS UYGULAMA DETAYI
09-101-00		CC-101-41.1	45 pieces parça	41.1 mm	45T-102-00 45T-103-00	
09-101-00		CC-101-26.5	75 pieces parça	26.5 mm	45T-103-00	





CODE KOD	DRAWING ÇİZİM	APPLICATION PROFILES UYGULAMA PROFİLLERİ	APPLICATION DETAILS UYGULAMA DETAYI
LC-1141		45T-102-00 45T-103-00	
LC-1127		45T-103-00	
LC-107		45T-102-00 45T-103-00 45T-201-00 45T-202-00 45T-203-00 45T-204-00	
02923000		45T-201-00 45T-202-00 45T-203-00 45T-204-00	
02921000		45T-201-00 45T-202-00 45T-203-00 45T-204-00	
MS 13		1621	







WITH GLAZING BEAT

GLAZING THICKNESS ÇİZİM	GLAZING GASKET INSIDE İÇ CAM FİTLİ	GLAZING GASKET OUTSIDE DİŞ CAM FİTLİ	GLAZING BEAD CAM ÇİTASI
20 mm	EM1-04	EM2-01	45-803-00
22 mm	EM1-02	EM2-01	45-803-00
24 mm	EM1-04	EM2-01	45-802-00
26 mm	EM1-02	EM2-01	45-802-00

ACCESSORY CODE AKSESUAR KODU	DRAWING ÇİZİM	PROFILES PROFİLLER	APPLICATION DETAIL UYGULAMA DETAYI
EM45-11		PVC	
EM45-12		Polyamid	
EM45-14		PVC Profile	
EM10-01 (White / Beyaz)		Drainage Cap Tahliye Kapağı	
EM10-02 (Black / Siyah)			
EM10-03 (Brown / Kahverengi)			
EM10-04 (Gray / Gri)			

CODE KOD	DESCRIPTION AÇIKLAMA	PICTURE RESİM	SLIDE SÜRME		LIFT & SLIDE KALDIR SÜR	
			80 kg	160 kg	80 kg	200 kg
02910000	Pulley With Wheel Sürme Tekli Rulman		x			
02911000	Pulley With 2 Wheels Sürme İkili Rulman			x		
02912000	Kit Pulleys L & S 1 Wheel + Mechanism Kaldır Sür Tekli Rulman Takımı				x	
02913000	Kit Pulleys L & S 2 Wheels + Mechanism Kaldır Sür İkili Rulman Takımı					x
02931000	Locking Kit Dil ve Karşılık		x	x	x	x
02935000	Central Plugs Kit For Sliding Sürme Kapak ve Hava Kesici Takımı		x	x		
02943000	Central Plugs Kit For L&S Kaldır Sür Kapak ve Hava Kesici Takımı				x	x
02933000	Shock Absorber And Lift Proof Plugs Kit For Sliding Sürme Stoper		x	x		
02939000	Shock Absorber And Lift Proof Plugs Kit For L&S Kaldır Sür Stoper				x	x

CODE KOD	DESCRIPTION AÇIKLAMA	PICTURE RESİM
02947000	Cap For 4 Sash 4 Kanat Adaptör Kapağı	
02954000	Fixed Sash Kit Sabit Kanat Mesafe Takozu	
02951000	Internal Device (For Handle) Kare Millî Kol İletişim Ekipmanı	
02940000	Cremone Driving Rod Maçalı Kol İletişim Ekipmanı	
MS 20	Fly Screen Pulley Sineklik Rulmanı	

CODE KOD	DESCRIPTION AÇIKLAMA	PICTURE RESİM	SLIDE SÜRME		LIFT & SLIDE KALDIR SÜR	
			80 kg	160 kg	80 kg	200 kg
EM45 - 91	Embedding Handle Havuz Kol ve İletişim Ekipmanı		x	x		
EM45 - 92	Embedding Handle With Lock Kilitli Havuz Kol ve İletişim Ekipmanı		x	x		
EM45 - 93	Embedding Lever Handle Kaldır Sür İçin Havuz Kol ve İletişim Ekipmanı					x
EM45 - 94	Handle Kara Millî Kol ve İletişim Ekipmanı		x	x	x	x
EM45 - 95	Handle With Lock Kilitli Kara Millî Kol ve İletişim Ekipmanı		x	x	x	x
EM45 - 96	Cremone Tek Maçalı Kol ve İletişim Ekipmanı		x	x		
02980000	Pulling Handle Çekme Kol		x	x		

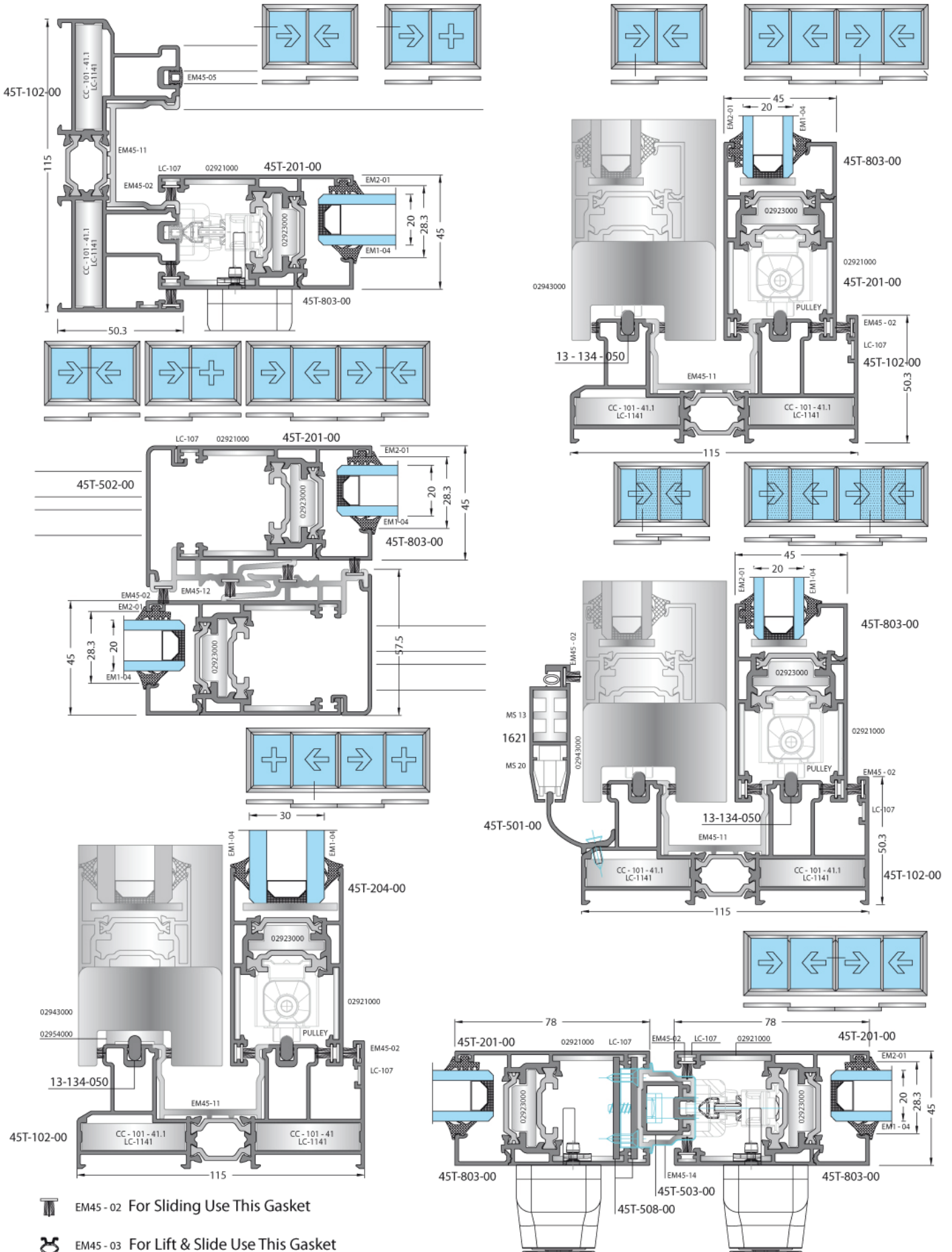

 EM45 - 02 For Sliding Use This Gasket

 EM45 - 03 For Lift & Slide Use This Gasket



Produced by 

KURTOĞLU BAKIR KURŞUN SAN. A.Ş.

Hacıseremet Mevkii, Tem Çorlu Çıkışı Velimeşe 59880 Pk 323 Tekirdağ / TÜRKİYE

T: +90 282 684 70 00 F: +90 282 684 70 01

www.kurtogluas.com kurtoglu@kurtogluas.com

 **Lorenzoline**[®]
aluminium profile system